

# IC- $\mu$ 2A/AT/E

INSTRUCTION MANUAL

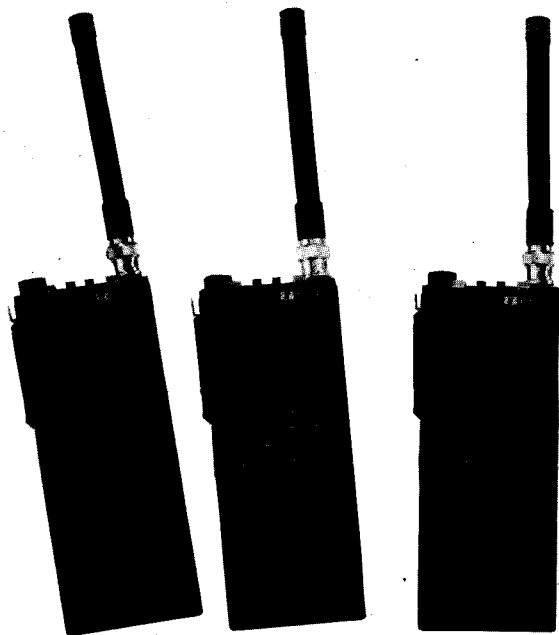

## FOREWORD

ICOM announces the debut of a versatile newcomer in the Amateur radio field - the **IC- $\mu$ 2A/AT/E** pocket-sized handheld transceiver.

Exceptionally flexible for a variety of uses yet surprisingly compact and easy to handle, the **IC- $\mu$ 2A/AT/E** is a complete, high performance integrated handheld - the beneficiary of the very latest in ICOM technical know-how and state-of-the-art integrated engineering.

To fully enjoy the use of your new **IC- $\mu$ 2A/AT/E** handheld, please study this instruction manual thoroughly prior to operation. Also, feel free to contact your nearest authorized ICOM Dealer if you have any questions relating to the operation of this transceiver.

## UNPACKING

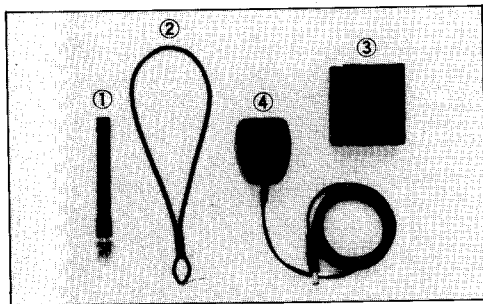

The picture shows accessories for the IC- $\mu$ 2A/AT U.S.A. versions.

Accessories included with the IC- $\mu$ 2A/AT/E	QTY.
1. Flexible antenna .....	1
2. Handstrap .....	1
3. Battery pack (BP-22) .....	1
4. Wall charger* .....	1

\* U.S.A. version : BC-25U  
Australia version : BC-27  
Europe version : BC-26E

## TABLE OF CONTENTS

	<b>WARNINGS</b> . . . . .	1
<b>SECTION</b>	<b>1 FEATURES</b> . . . . .	2
<b>SECTION</b>	<b>2 CONTROL FUNCTIONS</b> . . . . .	3
	2-1 TOP PANEL . . . . .	5
	2-2 FRONT AND SIDE PANEL . . . . .	8
	2-3 REAR PANEL . . . . .	10
<b>SECTION</b>	<b>3 PRE-OPERATION</b> . . . . .	11
	3-1 BATTERY PACK INSTALLATION . . . . .	11
	3-2 ANTENNA CONNECTION . . . . .	12
	3-3 FOR OUTDOOR USE . . . . .	12
<b>SECTION</b>	<b>4 GENERAL OPERATION</b> . . . . .	13
	4-1 SETTING FREQUENCY . . . . .	13
	4-2 RECEIVING . . . . .	14
	4-3 TRANSMITTING . . . . .	15
<b>SECTION</b>	<b>5 FUNCTIONS OPERATION</b> . . . . .	17
	5-1 SETTING OFFSET FREQUENCY . . . . .	17
	5-2 DTMF OPERATION (IC- $\mu$ 2AT ONLY) . . . . .	18
	5-3 SUBAUDIBLE TONE OPERATION (IC- $\mu$ 2AT ONLY) . . . . .	19
	5-4 TONE CALL OPERATION (IC- $\mu$ 2E ONLY) . . . . .	20
	5-5 MEMORY CHANNEL OPERATION . . . . .	20
	5-6 LOCK FUNCTION . . . . .	21
<b>SECTION</b>	<b>6 CAUTIONS AND MAINTENANCE</b> . . . . .	22
	6-1 CAUTIONS . . . . .	22
	6-2 MALFUNCTIONS . . . . .	22
<b>SECTION</b>	<b>7 TROUBLESHOOTING</b> . . . . .	25
<b>SECTION</b>	<b>8 BLOCK DIAGRAM</b> . . . . .	26
<b>SECTION</b>	<b>9 SPECIFICATIONS</b> . . . . .	27
<b>SECTION</b>	<b>10 SCHEMATIC DIAGRAM</b> . . . . .	SEPARATE

## WARNINGS

● Avoid using the transceiver under the following conditions:

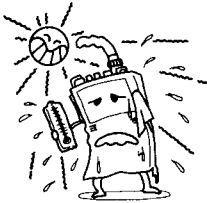

– In places subject to excessive heat or cold



– In places subject to excessive dust

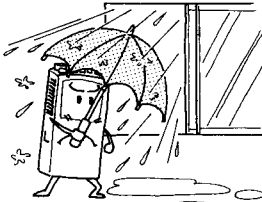

– In places subject to excessive humidity, including bathrooms



– In places subject to excessive vibrations

## SECTION 1 FEATURES

- **ULTRA COMPACT DESIGN**

The IC- $\mu$ 2A/AT/E measures only \*58mm wide by \*140mm high by \*29mm deep. This small, light-weight, ultra compact handheld transceiver comes in handy for use any time, whether outdoors, in your car, or at home.

\* Projections not included.
- **EASY FREQUENCY ENTRY**

Frequency entry can be easily performed with the top panel **Digital Touchstep** switches.
- **10 MEMORY CHANNELS**

Though ultra compact in design, the IC- $\mu$ 2A/AT/E has a total of ten programmable memory channels.
- **EASY-TO-READ DISPLAY**

A new Liquid Crystal Display with soft green illumination gives the user excellent operating visibility even in dark environments. This LCD indicates the operating frequency as well as the memory channel number.
- **POWER SAVER DESIGN**

All circuits were designed using low power dissipation techniques with a special power saver circuit. The power saver circuit functions if no signal is received or no switch operation is performed for more than 30 seconds, and requires only 1/4 current flow during regular receiving conditions.

## SECTION 2 CONTROL FUNCTIONS

### 2-1 TOP PANEL

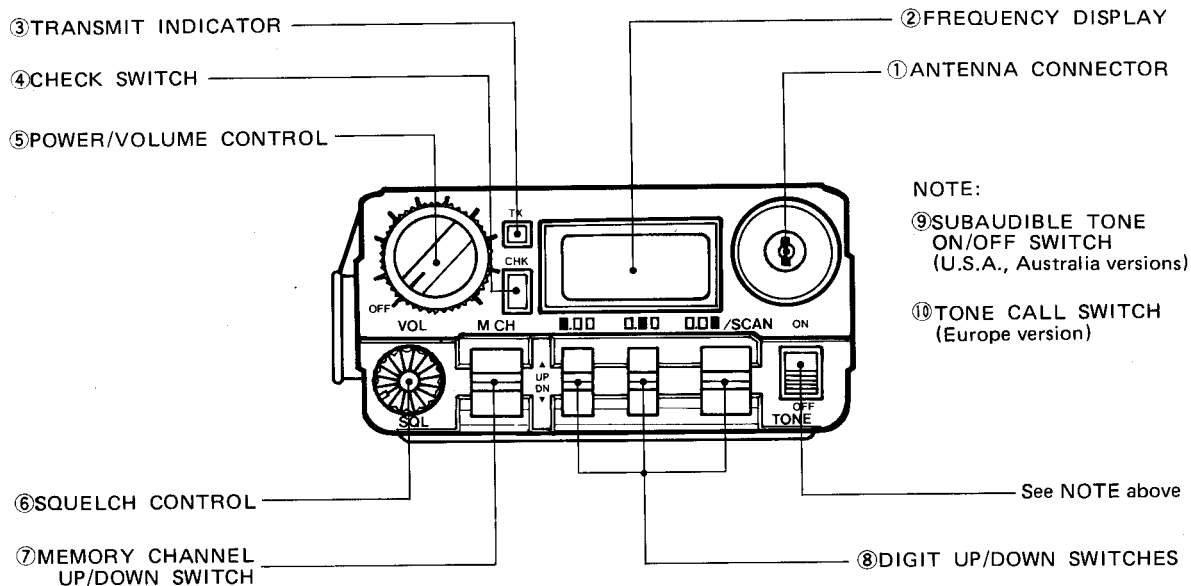

\*This diagram shows the IC- $\mu$ 2A/AT versions.

## 2-2 FRONT AND SIDE PANEL

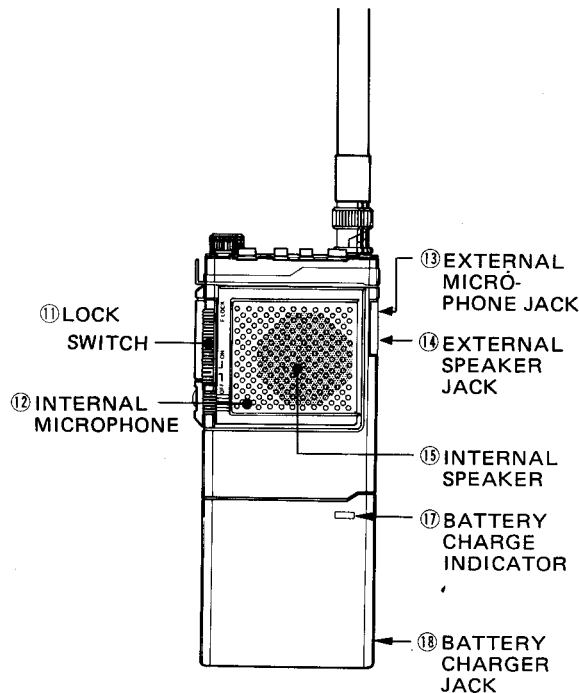

## 2-3 REAR PANEL

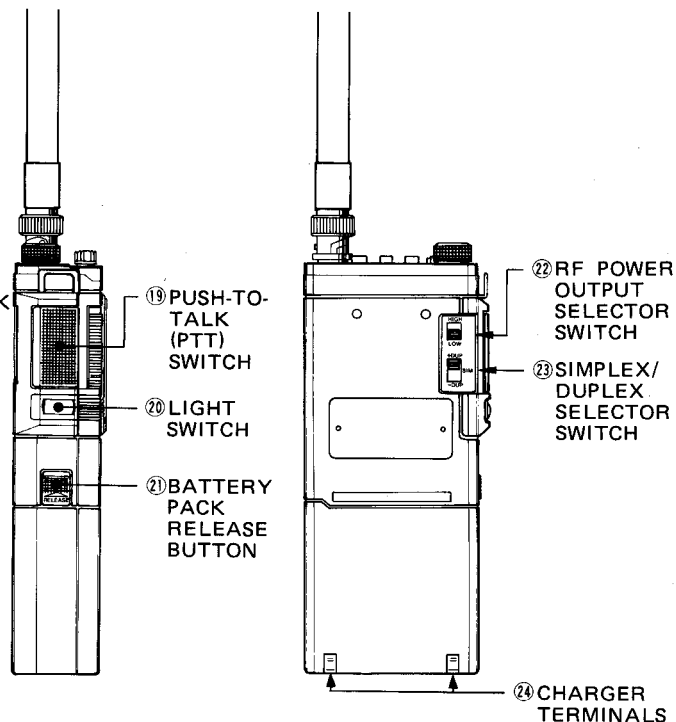

\*These diagrams show the IC- $\mu$ 2A/E versions.

## 2-1 TOP PANEL

### ① ANTENNA CONNECTOR

Connect the supplied flexible antenna.

**CAUTION:** Transmitting without an antenna may damage the transceiver.

### ② FREQUENCY DISPLAY

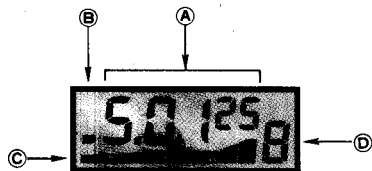

 : 130MHz band

\*  : 140MHz band

 : 150MHz band

 : 160MHz band

 : 170MHz band

Indicates not only the operating frequency but also memory channel number and S-level/Power selection indicator functions.

#### ① FREQUENCY INDICATOR:

Shows the current operating frequency.

#### ② 10MHz DIGIT INDICATOR:

Shows the 10MHz digit of a frequency. \*The Australia and Europe versions indicate only one dot for the 140MHz band.

#### ③ S-LEVEL/POWER SELECTION INDICATOR

Indicates signal strength and selection of the RF POWER OUTPUT SELECTOR SWITCH with bars. The bars only indicate relative switch positions.

- LOW power : 3 segments appear
- HIGH power : All segments appear

#### ④ MEMORY CHANNEL:

Indicates a memory channel number.



- ③ **TRANSMIT INDICATOR [TX]** Lights up while transmitting.

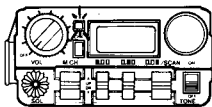

Indicates that the transceiver is transmitting and also the condition of the batteries. If the indicator goes out while transmitting, the battery pack is exhausted and should be charged again.

- ④ **POWER/VOLUME CONTROL [VOL]**



Rotate clockwise to turn the transceiver ON and increase the audio level.

- ⑤ **CHECK SWITCH [CHK]**

Allows the operator to monitor the transmit frequency when the duplex mode is selected while pressing this switch.

- ⑥ **SQUELCH CONTROL [SQL]**

Raises the threshold level.



Sets the squelch threshold level. Rotate this control fully counter-clockwise to turn OFF the squelch function, and clockwise to raise the threshold level.

- ⑦ **MEMORY CHANNEL UP/DOWN SWITCH [M CH]**



Push either upward or downward to change the selected memory channel. See SECTION 5 - 5 for more information.

### ⑧ DIGIT UP/DOWN SWITCHES

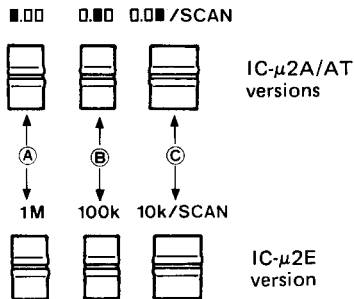

### ① 1MHz DIGIT UP/DOWN SWITCH:

Push either upward or downward to change the 1MHz digit numbers.

### ② 100kHz DIGIT UP/DOWN SWITCH:

Push either upward or downward to change the 100kHz digit numbers.

### ③ 10kHz DIGIT UP/DOWN SWITCH:

Push either upward or downward to change the minimum frequency step of each version.

### ⑨ SUBAUDIBLE TONE ON/OFF SWITCH [TONE] (IC- $\mu$ 2AT version)

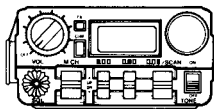

SUBAUDIBLE TONE SWITCH

Slide to switch the subaudible tone encoder ON and OFF when using the duplex mode. See SECTION 5 - 3 for more information.

### ⑩ TONE CALL SWITCH [CALL] (IC- $\mu$ 2E version)

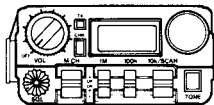

TONE CALL SWITCH

Push to transmit the 1750Hz tone for accessing repeaters. See SECTION 5 - 4 for more information.

## 2-2 FRONT AND SIDE PANEL

### ⑪ LOCK SWITCH [F.LOCK]



This switch prevents accidental frequency and memory channel changes.

### ⑫ INTERNAL MICROPHONE

This microphone operates when the transceiver is transmitting. However, it will not operate if an external microphone is connected to the EXTERNAL MICROPHONE JACK.

### ⑬ EXTERNAL MICROPHONE JACK [MIC]

The optional IC-HM9 SPEAKER-MICROPHONE can be connected for additional versatility to the EXTERNAL MICROPHONE JACK. The internal microphone does not function when an external microphone is connected.

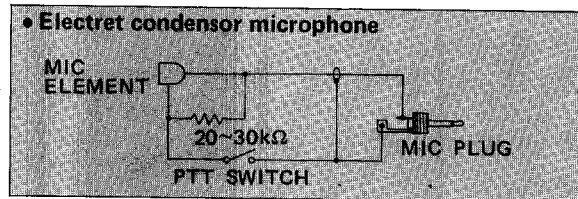
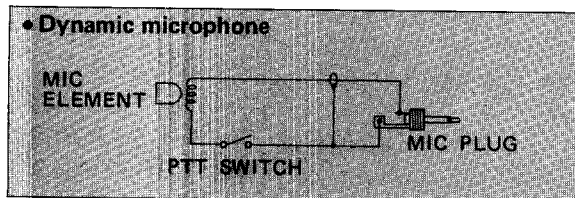

**⑭ EXTERNAL SPEAKER JACK**  
**[EXT SP]**

Connect an 8Ω external speaker to this jack. The INTERNAL SPEAKER will not operate if an external speaker is connected to the EXTERNAL SPEAKER JACK.

**⑮ INTERNAL SPEAKER**

This speaker operates when the transceiver is receiving. However, it will not operate if an external speaker is connected to the EXTERNAL SPEAKER JACK.

**⑯ DTMF KEY PAD**  
**(IC-μ2AT version)**

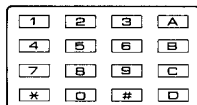

Keys on this pad are used for accessing a repeater or making an auto-phone-patch.

**⑰ BATTERY CHARGE**  
**INDICATOR**

Lights up while battery pack is charging with the supplied wall charger or the optional IC-CP1.

**⑱ BATTERY CHARGER JACK**

This jack accepts the output plug of the supplied BC-25U, BC-26E, and BC-27 WALL CHARGERS or 13.8V DC power source.

**⑲ PTT (PUSH-TO-TALK) SWITCH** Push this switch to begin transmitting.

**⑳ LIGHT SWITCH**

Press this switch to turn ON and OFF the backlight for the FREQUENCY DISPLAY. The backlight has a timer function and will turn OFF automatically unless switches are being used.

②1 BATTERY PACK RELEASE  
BUTTON [RELEASE]



Push this button upwards and slide the battery pack out to remove it from the transceiver.

2 - 3 REAR PANEL

②2 RF POWER OUTPUT  
SELECTOR SWITCH  
[HIGH] [LOW]



Selects the RF output power. Set the switch to the [HIGH] position for 1W and the [LOW] position for 0.1W.

②3 SIMPLEX/DUPLEX  
SELECTOR SWITCH  
[+DUP] [SIM] [-DUP]



Selects either the simplex or duplex mode.

②4 CHARGER TERMINALS

These terminals are used for battery charging with BC-50U/E.

## SECTION 3 PRE-OPERATION

### 3-1 BATTERY PACK INSTALLATION

#### (1) Using the BP-22 BATTERY PACK

The supplied BP-22 BATTERY PACK is rechargeable and can be easily slipped ON or OFF the transceiver.

- 1) To recharge the battery pack use the supplied wall charger or the optional BC-50U/E DESK BATTERY CHARGER, or a 12V-type cigarette lighter socket with the IC-CP1 CIGARETTE LIGHTER CABLE.
- 2) Battery charging takes about 15 hours using either the supplied wall charger or the optional IC-CP1. It takes about 1 hour using the optional BC-50U/E.

TRANSCEIVER	SUITABLE BATTERY CHARGER		
IC- $\mu$ 2A, IC- $\mu$ 2AT (U.S.A. version)	*BC-25U	BC-50U (117V) (Option)	IC-CP1 (Option)
IC- $\mu$ 2A (Australia version)	*BC-27	BC-50E (240V) (Option)	IC-CP1 (Option)
IC- $\mu$ 2E (Europe version)	*BC-26E	BC-50E (220V) (Option)	IC-CP1 (Option)

\*Supplied with IC- $\mu$ 2A/AT/E.

## (2) Battery pack note

The full charge capacity of NiCd rechargeable batteries may be reduced if repeatedly charged with only partial discharge periods. This is called the battery memory effect. If the battery capacity seems lower than new, discharge the pack through normal use, then charge fully using the proper charger.

## 3 - 2 ANTENNA CONNECTION

Insert the connector on the flexible rubber antenna into the ANTENNA CONNECTOR on the top panel.

## 3 - 3 FOR OUTDOOR USE

- 1) Attach the handstrap to the projecting metal loop on the side of the transceiver as shown in the diagram.
- 2) An optional MB-20 BELT CLIP is available.

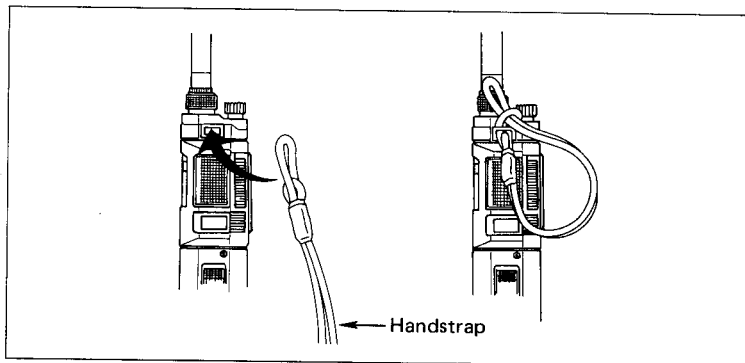

## SECTION 4 GENERAL OPERATION

### 4-1 SETTING FREQUENCY

1) Turn power ON.

1) Turn power ON.

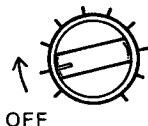

2) Push either FREQUENCY SETTING SWITCH upward or downward.

2) Push either FREQUENCY SETTING SWITCH upward or downward to set the frequency.

- The 10kHz and 1MHz DIGIT UP/DOWN SWITCHES have a digit carrying function. While these switches are pushed the frequency moves continuously up or down.

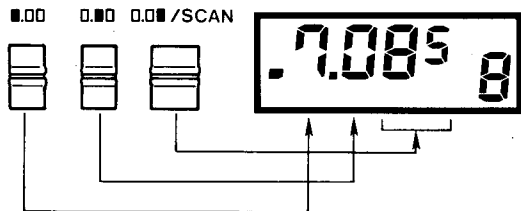

IC- $\mu$ 2A/AT versions

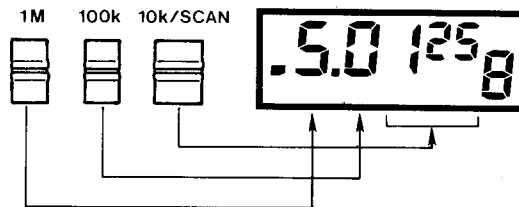

IC- $\mu$ 2E version



## 4 - 2 RECEIVING

- 1) Turn power ON and adjust the [VOL] CONTROL.

Increases the audio level.

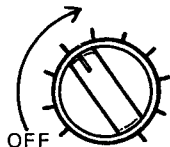

- 2) Adjust the [SQL] CONTROL.

Raises the threshold level.

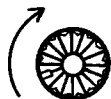

- 1) Turn power ON and adjust the [VOL] CONTROL to a suitable listening level.

- 2) Adjust the [SQL] CONTROL until the noise is quieted.

- 3) Set the desired frequency using the FREQUENCY UP/DOWN SWITCHES. Refer to SECTION 4 - 1 for setting the frequency.

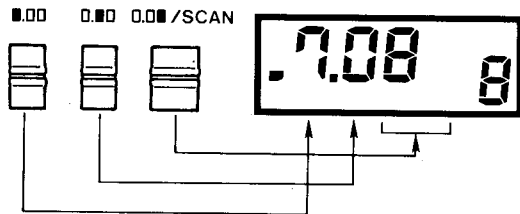

## 4 - 3 TRANSMITTING

1) Turn power ON.

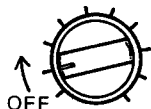

1) Turn power ON.

2) Select output power.



2) Select output power.

- [HIGH] : 1W
- [LOW] : 0.1W

3) Select either simplex or duplex mode.

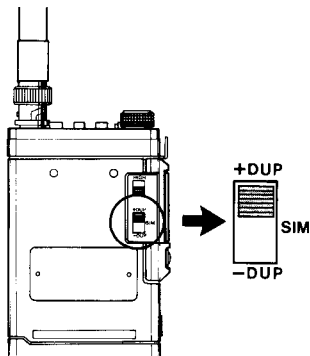

3) Select either simplex or duplex mode.

- Simplex [SIM] mode:  
Transmit and receive frequencies are the same.
- Duplex [+DUP] or [-DUP] mode:  
Transmit and receive frequencies are normally different for 600kHz. See SECTION 5 - 1 for setting offset frequency.

4) Press the [PTT] SWITCH to begin transmitting and speak into the microphone.

- The red [TX] INDICATOR lights up.
- RF INDICATOR appears and shows relative output power on the FREQUENCY DISPLAY.

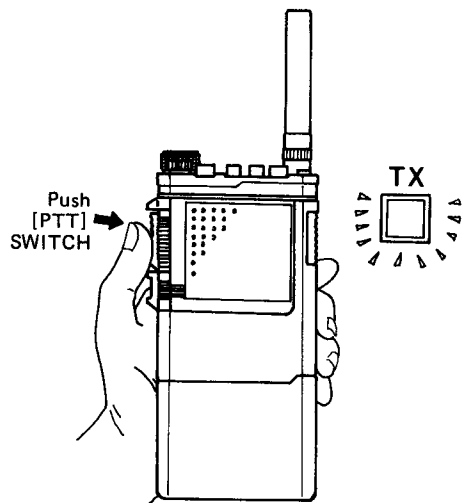

[High power output]



[Low power output]



## SECTION 5 FUNCTIONS OPERATION

### 5 - 1 SETTING OFFSET FREQUENCY

- 1) Turn power OFF.

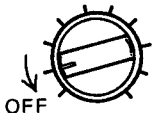

- 2) Set either to [+DUP] or [-DUP] position.



- 3) Hold down the [LIGHT] SWITCH and turn power ON.



The offset frequency for duplex operation is preset for 600kHz. However, the frequency can be changed by the following method:

- 1) Turn power OFF.

- The frequency indicator disappears.

- 2) Set the DUPLEX/SIMPLEX SELECTOR SWITCH to either the [+DUP] or [-DUP] positions.

- Set either in the [+DUP] or [-DUP] position and NOT in the [SIM] position.

- 3) Push and hold the [LIGHT] SWITCH and turn the power ON. Then, release the [LIGHT] SWITCH.

- The offset frequency appears.

- The offset frequency displayed in the diagram shows 600kHz.

4) Set the desired offset frequency.

4) Set the desired offset frequency by using the DIGIT UP/DOWN SWITCHES. The frequency can be set up to 39.995MHz (or 39.9875MHz for the IC- $\mu$ 2E version).

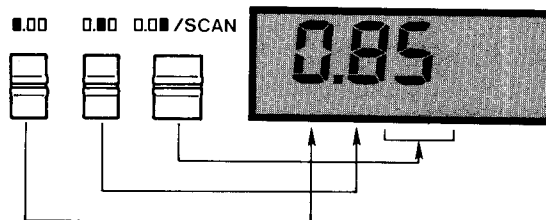

5) Push either the [PTT] or [CHK] SWITCH.

5) Push either the [PTT] or [CHK] SWITCH to set the offset frequency and return to your normal operating mode.

## 5-2 DTMF OPERATION (IC- $\mu$ 2AT ONLY)

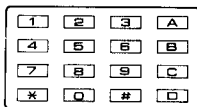

If you need DTMF tones to access a repeater or to make an auto phone-patch, follow the procedure below.

1) Push keys the desired number of times while pressing the [PTT] SWITCH.

2) After the first number has been entered, the transceiver will maintain transmit mode for about one second.

## 5-3 SUBAUDIBLE TONE OPERATION

(IC- $\mu$ 2AT ONLY)

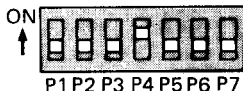

When the P7 SWITCH is set in the ON position, the tone function is always turned ON regardless of the [TONE] SWITCH position.

The built-in subaudible tone encoder allows access to repeater stations that require subaudible tones superimposed on the transmit signal in order for their receiver squelch circuits to be opened.

- 1) Turn the [TONE] SWITCH ON to activate the subaudible tone encoder function.
- 2) The tone frequency can be changed by the tone frequency selector switches as shown in the diagram. See the SUBAUDIBLE TONE FREQUENCY TABLE to set the tone frequency.

### •SUBAUDIBLE TONE FREQUENCY TABLE

FREQUENCY [Hz]	SWITCH POSITIONS						FREQUENCY [Hz]	SWITCH POSITIONS						FREQUENCY [Hz]	SWITCH POSITIONS					
	P1	P2	P3	P4	P5	P6		P1	P2	P3	P4	P5	P6		P1	P2	P3	P4	P5	P6
67.0	1	0	0	0	0	0	107.2	0	1	1	1	0	0	167.9	1	1	0	1	1	0
71.9	0	1	0	0	0	0	110.9	1	1	1	1	0	0	173.8	0	0	1	1	1	0
74.4	1	1	0	0	0	0	114.8	0	0	0	0	1	0	179.9	1	0	1	1	1	0
77.0	0	0	1	0	0	0	118.8	1	0	0	0	1	0	186.2	0	1	1	1	1	0
79.7	1	0	1	0	0	0	123.0	0	1	0	0	1	0	192.8	1	1	1	1	1	0
82.5	0	1	1	0	0	0	127.3	1	1	0	0	1	0	203.5	0	0	0	0	0	1
85.4	1	1	1	0	0	0	131.8	0	0	1	0	1	0	210.7	1	0	0	0	0	1
88.5	0	0	0	1	0	0	136.5	1	0	1	0	1	0	218.1	0	1	0	0	0	1
91.5	1	0	0	1	0	0	141.3	0	1	1	0	1	0	225.7	1	1	0	0	0	1
94.8	0	1	0	1	0	0	146.2	1	1	1	0	1	0	233.6	0	0	1	0	0	1
97.4	1	1	0	1	0	0	151.4	0	0	0	1	1	0	241.8	1	0	1	0	0	1
100.0	0	0	1	1	0	0	156.7	1	0	0	1	1	0	250.3	0	1	1	0	0	1
103.5	1	0	1	1	0	0	162.2	0	1	0	1	1	0							

1: ON

0: OFF

## 5 - 4 TONE CALL OPERATION (IC- $\mu$ 2E ONLY)

- 1) Press the [TONE] SWITCH.



- 2) The tone transmits.

## 5 - 5 MEMORY CHANNEL OPERATION

### (1) Memory reading

- 1) Turn power ON.
- 2) Push the [M CH] SWITCH.

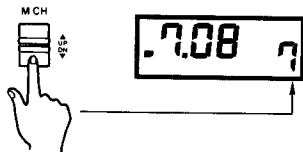

The IC- $\mu$ 2E is equipped with a 1750Hz tone generator for accessing repeaters.

- 1) Press the [TONE] SWITCH on the top panel.

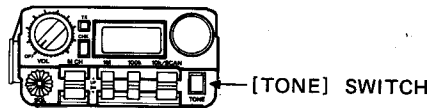

- 2) The tone transmits while the [TONE] SWITCH is pressed. Most repeaters require tones between 1sec. and 3sec. to be opened.

The IC- $\mu$ 2A/AT/E is equipped with ten memory channels. Following are procedures for memory reading and memory writing.

- 1) Turn power ON.
- 2) Push the [M CH] MEMORY CHANNEL UP/DOWN SWITCH either upward or downward to select the desired memory channel.
  - The frequency displayed can be changed by any of the DIGIT UP/DOWN SWITCHES.

## (2) Memory writing

- 1) Turn power ON.
- 2) Select memory channel.

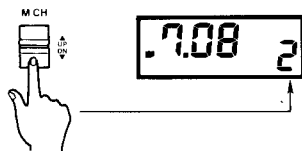

- 3) Set the desired frequency.

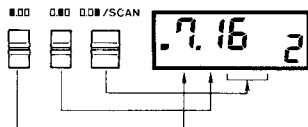

## 5 - 6 LOCK FUNCTION



- 1) Turn power ON.
- 2) Select a memory channel you would like to store the frequency in by using the [M CH] MEMORY CHANNEL UP/DOWN SWITCH.

- 3) Set the desired frequency by pressing any of the DIGIT UP/DOWN SWITCHES on the top panel. The displayed frequency will be stored in the selected memory channel automatically.

- The last displayed frequency will be stored in the memory channel.

This function prevents accidental frequency and memory channel changes.

Slide the [F.LOCK] SWITCH to the [ON] position to activate the lock function and to the [OFF] position to release the function.



## SECTION 6 CAUTIONS AND MAINTENANCE

### 6-1 CAUTIONS



Avoid the use of strong cleaning agents such as benzine or alcohol as they may damage the surfaces.



DO NOT disassemble the transceiver as it may cause trouble.

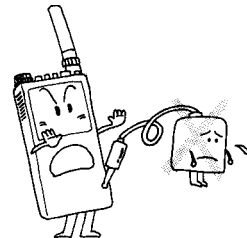

DO NOT use any chargers other than the suggested ones.

### 6-2 MALFUNCTIONS

#### (1) Unlocked PLL

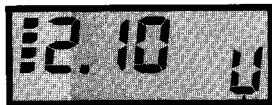

Unlocked sign

If malfunctioning occurs, stop using the transceiver immediately and see the instructions below for solving the problem.

If a small "U" appears on the FREQUENCY DISPLAY as shown at the left, the PLL (Phase-Locked Loop) circuit in the transceiver is unlocked.

- At this time, the transceiver is muted and no signals are transmitted. This unlocked condition may be caused by an exhausted battery pack, so check your battery first.

## (2) Resetting internal CPU

**CAUTION:** After resetting the CPU, all information you have programmed into the memory channels will be cleared. Memory channels must be re-programmed.

Occasionally, the FREQUENCY DISPLAY may display erroneous information either during operation or when first applying power. This may, for example, be due to an external cause such as static electricity.

When this sort of problem occurs, simply reset the internal CPU according to the following procedures:

1) Turn power OFF.

2) Switch to the [SIM] position.

3) Hold down the [LIGHT] SWITCH and turn power ON.

(Hold down)



[LIGHT] SWITCH

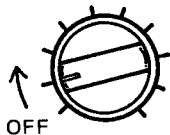

1) Turn power OFF.

2) Set the SIMPLEX/DUPLEX SELECTOR SWITCH to the [SIM] simplex position.

3) Hold down the [LIGHT] SWITCH and turn power ON. The CPU is now reset.

- All memory channel frequencies and the displayed frequency are reset at their initialized values.

### (3) CPU backup battery

The IC- $\mu$ 2A/AT/E uses a highly reliable CPU which is a complete, self-contained microprocessor. The purpose of the battery is to provide power to the CPU so it retains all memory information during power failures or in case the power pack is detached or turned OFF.

The usual life of the backup battery is approximately one to two years. Monitor the backup battery carefully and replace it if there are repeated cases of display malfunction.

**NOTE:** Battery replacement should be done by your nearest authorized ICOM Service Center.

- If the internal backup battery is exhausted, the IC- $\mu$ 2A/AT/E transmit and receive functions will still operate normally but no frequencies can be memorized in the memory channels.

## SECTION 7 TROUBLESHOOTING

PROBLEM	POSSIBLE CAUSE	SOLUTION
1. Power does not come ON when the power switch is turned ON.	<ul style="list-style-type: none"> <li>• The battery pack is exhausted.</li> </ul>	<ul style="list-style-type: none"> <li>• Replace the battery pack with a new one or recharge it.</li> </ul>
2. No sound comes from the speaker.	<ul style="list-style-type: none"> <li>• Squelch setting is turned too far clockwise.</li> <li>• External speaker or earphone is in use.</li> </ul>	<ul style="list-style-type: none"> <li>• Turn the [SQL] CONTROL CCW until noise can be heard. Turn CW so the noise just disappears.</li> <li>• Check if the external speaker plug is inserted properly or if the external speaker cable is cut.</li> </ul>
3. No or low power output.	<ul style="list-style-type: none"> <li>• RF POWER OUTPUT SELECTOR SWITCH is at the [LOW] position.</li> <li>• The battery pack is exhausted. ([TX] INDICATOR does not light.)</li> </ul>	<ul style="list-style-type: none"> <li>• Set the switch to [HIGH] position.</li> <li>• Replace the battery pack with a new one or recharge it.</li> </ul>
4. The receive mode functions properly and your signals are transmitted, but you are unable to make contact with another station.	<ul style="list-style-type: none"> <li>• Improper offset frequency or input/output frequencies of the repeater.</li> <li>• The transceiver is in SIMPLEX mode. (When desiring DUPLEX mode.)</li> </ul>	<ul style="list-style-type: none"> <li>• Set the proper offset frequency. See page 17 for information.</li> <li>• Set either to the [+DUP] or [-DUP] positions.</li> </ul>

# SECTION 8 BLOCK DIAGRAM

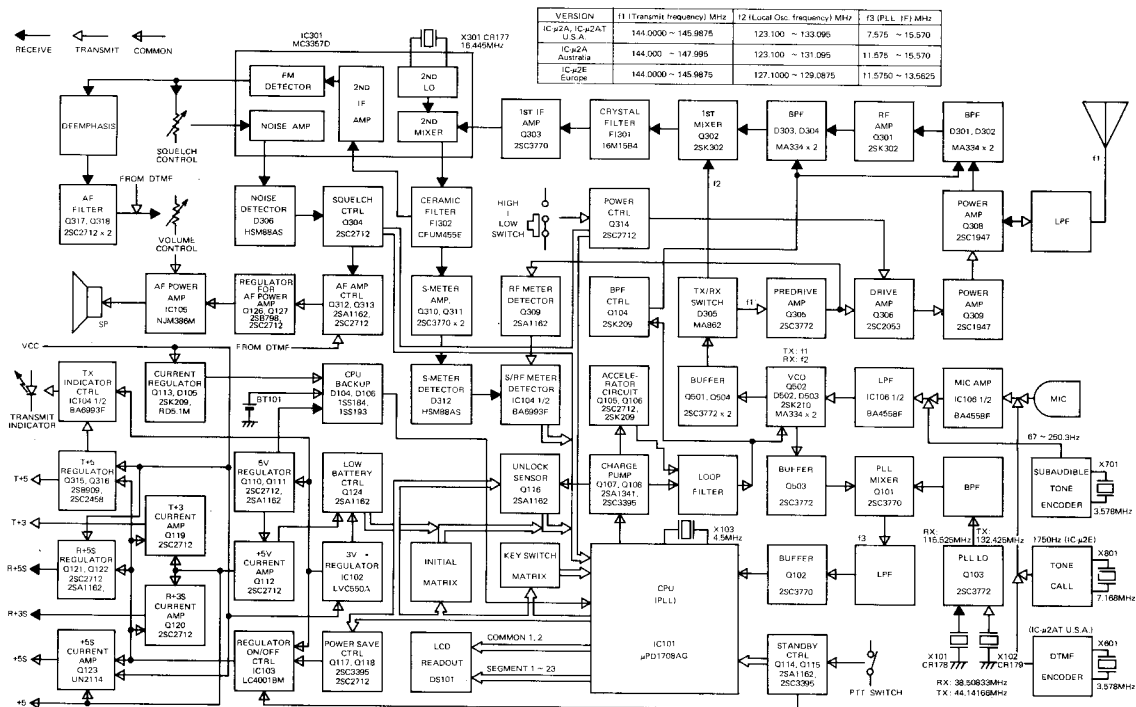

VERSION	F1 (Transmit frequency) MHz	F2 (Local Osc. frequency) MHz	F3 (PLL F1) MHz
IC #2A, IC #2AT U.S.A.	144.000 ~ 145.9875	123.100 ~ 133.095	7.575 ~ 15.570
IC #2A Australia	144.000 ~ 147.995	123.100 ~ 131.095	11.575 ~ 15.570
IC #2E Europe	144.000 ~ 145.9875	127.1000 ~ 129.0875	11.5750 ~ 13.5625

## SECTION 9 SPECIFICATIONS

### 9-1 GENERAL

● Frequency coverage :

MODEL	OPERATIONAL RANGE		
	TRANSCEIVER	RECEIVER	TRANSMITTER
IC- $\mu$ 2A/AT U.S.A. version	144.000 ~ 147.995	140.000 ~ 163.000	140.000 ~ 149.995
IC- $\mu$ 2A Australia version	144.000 ~ 147.995	144.000 ~ 147.995	144.000 ~ 147.995
IC- $\mu$ 2E	144.0000 ~ 145.9875	144.0000 ~ 145.9875	144.0000 ~ 145.9875

Unit : MHz

- Frequency resolution : IC- $\mu$ 2A/AT 5kHz IC- $\mu$ 2E 12.5kHz IC- $\mu$ 2E (Germany, Italy versions) 5kHz
- Antenna impedance : 50 $\Omega$  unbalanced
- Usable temperature : -10°C ~ +60°C
- Frequency stability :  $\pm 15$ ppm at 0°C ~ +60°C
- Current drain at 8.4V DC :
 

Receiving	Power saved	Approx. 6mA
	Squelched	Max. 30mA
	At max. audio output	Max. 170mA
Transmitting	High (1.0W)	Max. 600mA
	Low (0.1W)	Max. 300mA
- Dimensions (with BP-22) : 58(61)W x 140(148)H x 29(33)D mm  
Bracketed values include projections.
- Weight : 340g

### 9-2 TRANSMITTER

- Output power : HIGH 1.0W LOW 0.1W
- Emission mode : 16K0F3E
- Modulation system : Variable reactance frequency modulation
- Max. frequency deviation :  $\pm 5$ kHz
- Spurious emission : More than 60dB below carrier

### 9-3 RECEIVER

- Receiving system : Double-conversion superheterodyne
- Intermediate frequencies : 1st 16.9MHz 2nd 455kHz
- Modulation acceptance : 16K0F3E
- Sensitivity : Less than 0.25 $\mu$ V (-12dB $\mu$ ) for 12dB SINAD
- Squelch sensitivity (Threshold) : Less than 0.1 $\mu$ V (-20dB $\mu$ )
- Spurious response rejection ratio : More than 60dB
- Audio output power : More than 0.25W at 10% distortion with an 8 $\Omega$  load